



---

# **BRICK INSTALLATION**

---

Tools you will need:

1. Dark paint or dark fabric
2. Scissors
3. Manual stapler or nail gun
4. Plastic lattice
5. Drill, anchors, and concrete screws
6. Level

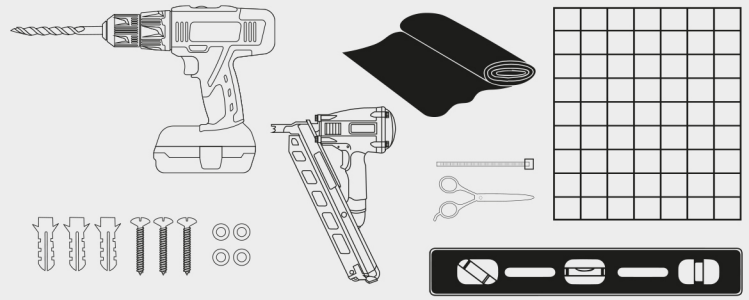

## Installation

### Step 1: Preparing for you installation

For a better finish and more depth to its natural appearance, it is recommended to cover the area with dark paint or black fabric.

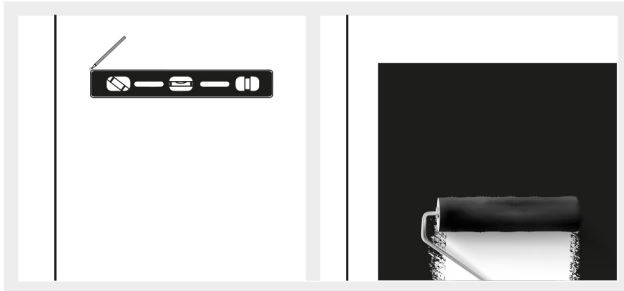

- Remember to use a level to ensure the installation is straight.
- Mark your installation area and cover it with dark paint or dark fabric.

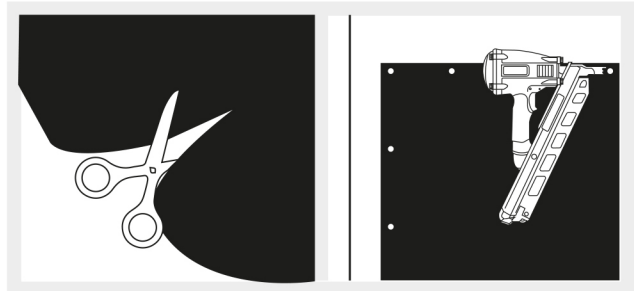

- Dark Fabric Installation: Cut the dark fabric to the size of the area you want to decorate. Use a manual stapler or nail gun to attach the fabric to the drywall. Start by installing the fabric in its corners and then inside, make sure to tightly stretch the fabric.

### Step 2: Prepare your Artificial Greenery panels

Open your box of Emerald Artificial Greenery and remove each panel and loosen the vegetation. Plants bloom towards the sun. Position your panels with the vegetation facing upwards for the most realistic look.

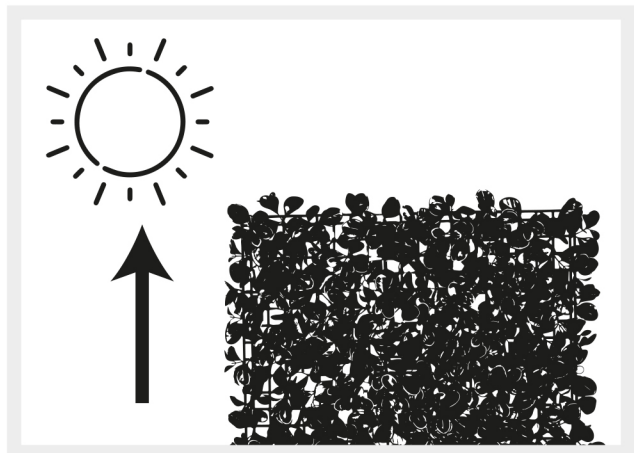
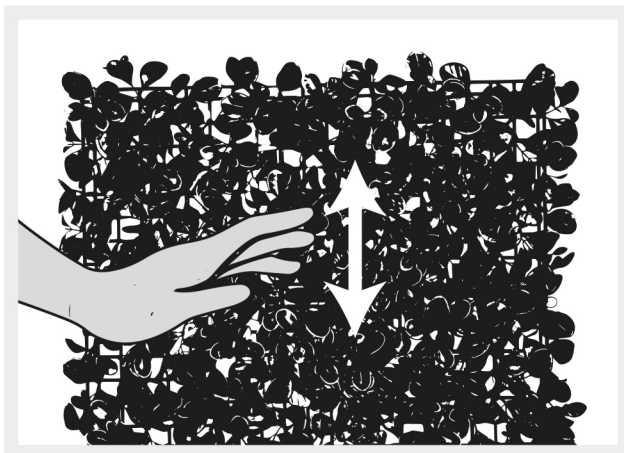

## Step 3: Install your panels

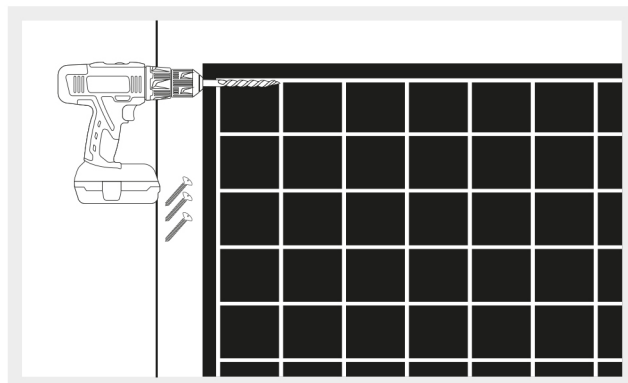
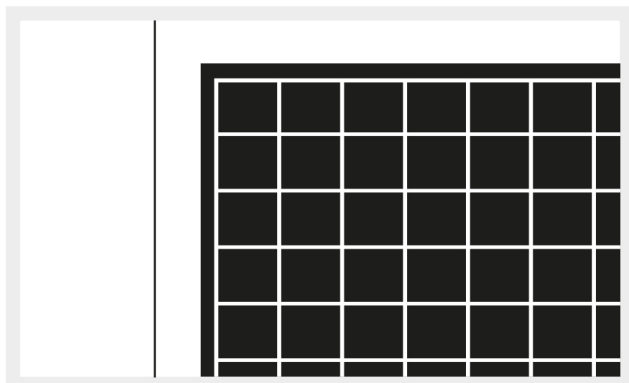

- Install the plastic lattice to minimize the number of holes in the wall and speed up the installation process. Position the lattice in the working area. Using a concrete screw, drill it to make a hole through both the lattice and the wall. Insert a plastic anchor into the hole and secure it with a concrete screw. Ensure the lattice is securely attached to the wall and that it is not lifting.

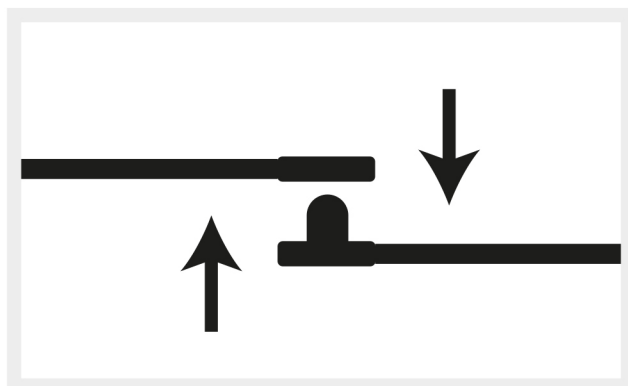
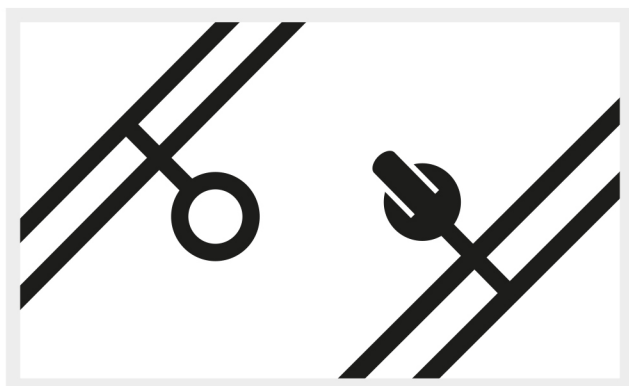

- Be careful when installing the panels; each panel has male and female connection points, so make sure to join them correctly.

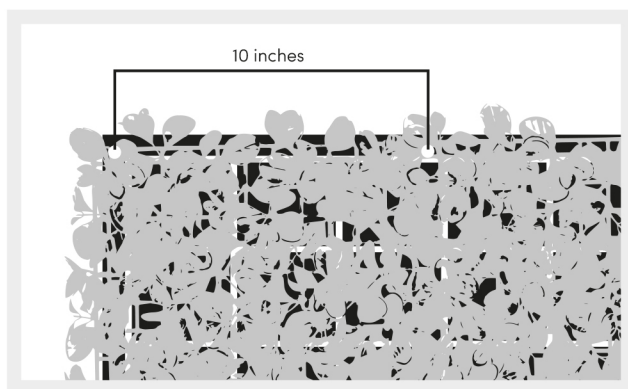
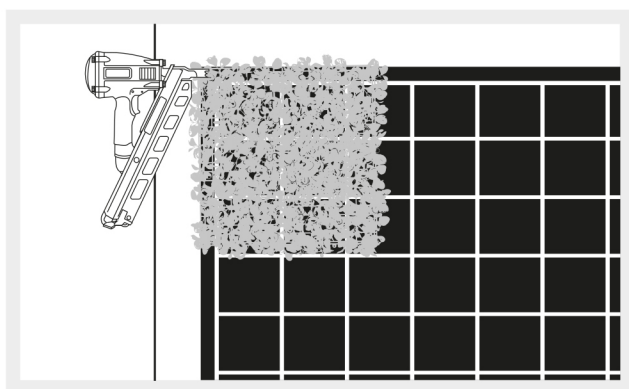

- To begin installing your greenery panels, place the first panel in the upper left corner and use a manual stapler or nail gun to secure it to the plastic lattice. To prevent the panel from detaching from the lattice, place additional staples at approximately 10-inch intervals. You can also use plastic zip ties to secure the panel to the lattice.

# Brick Installation

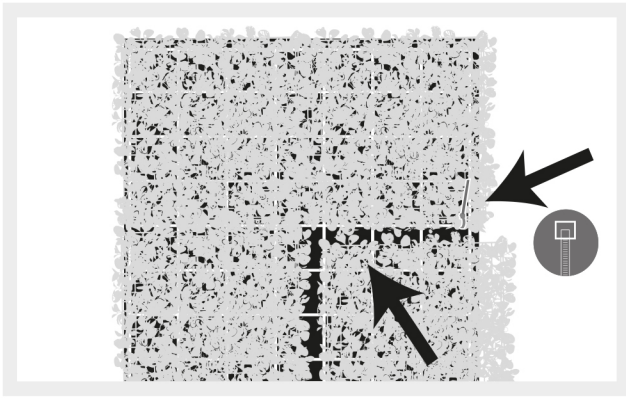

- Once the first panel is installed, connect the second panel, and secure it with staples or plastic zip ties. Repeat the procedure until the entire work area is covered.

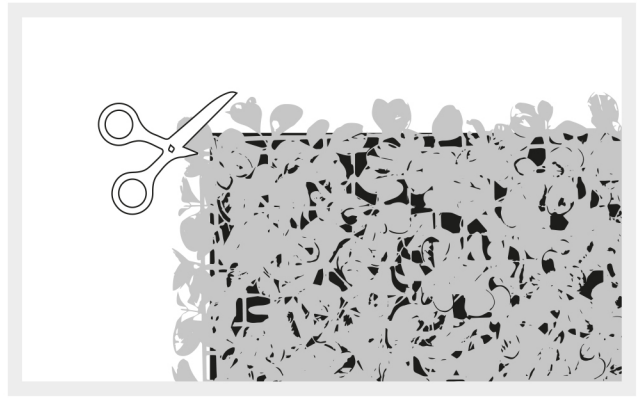

- Trim any artificial greenery excess with scissors.

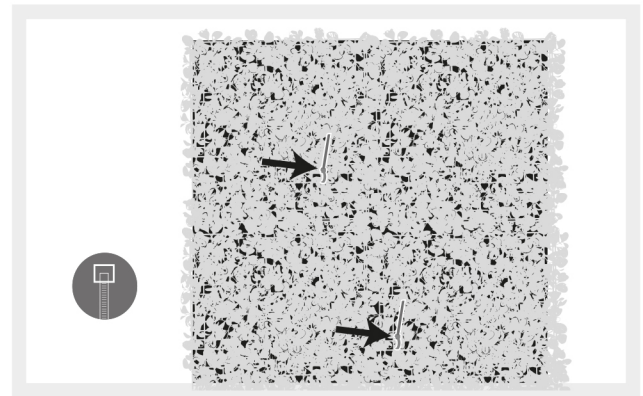
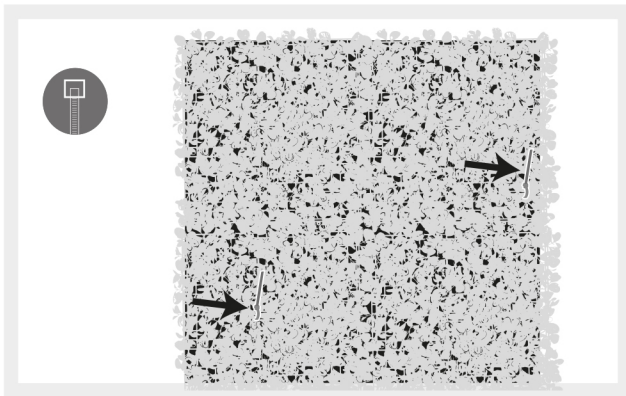

- Ensure the installation is secure by using additional staples or plastic zip ties within the artificial greenery. This will prevent the panel from coming loose.

## Step 4: Final detail

After completing the installation, run your hands over each panel to open the vegetation, and blend it. This step helps to unify the composition, making it look more realistic and natural.

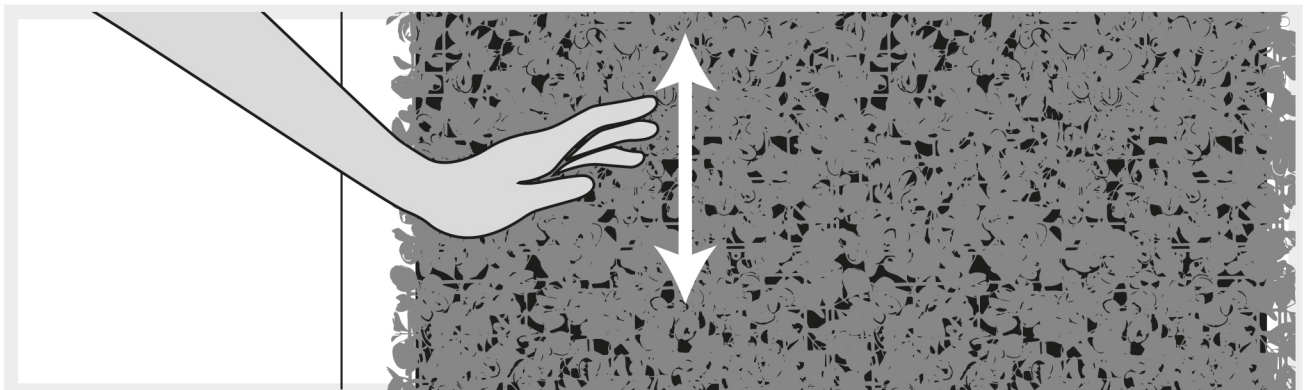

**That's all there is to it!**

**Now let's get to work and enjoy your beautiful artificial greenery installation.**